

TOOL Grazer 12

18,0 W/m • 5,5 W/ft

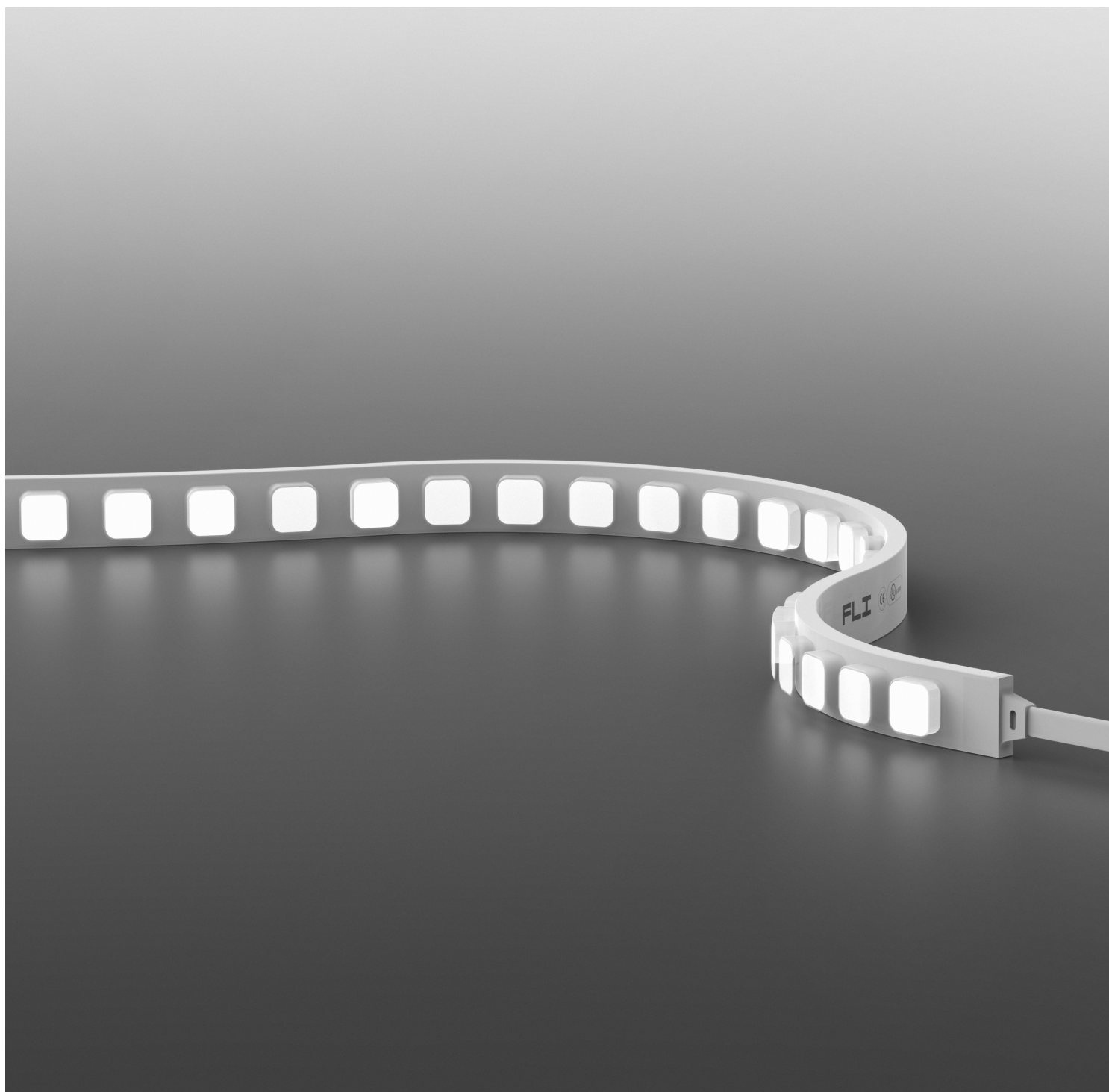

11,5 × 20,0 mm
0,45 × 0,79 "



TOOL Grazer 12

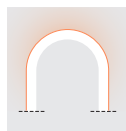
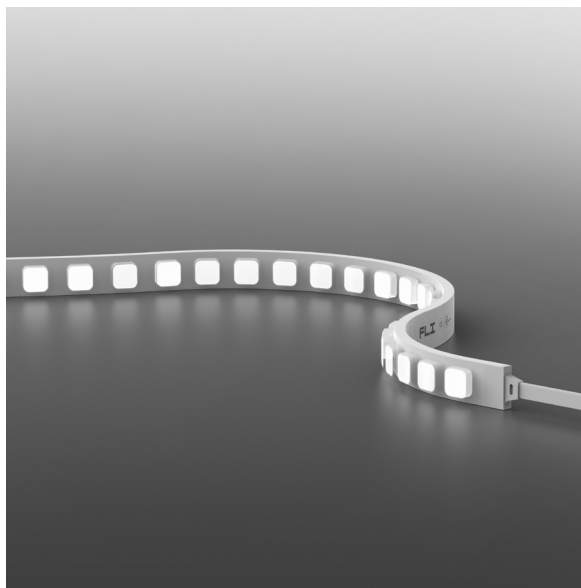

Vertical Bending

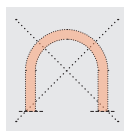

Horizontal Bending

Body Corpo

Flexible Strip LED Grazer 12

Strip LED flessibile Grazer 12

| | | |
|--|---|--|
| Features Caratteristiche | Consistency One Bin Saltwater Resistant Resistant to Solvents UV Protection Dimmable product | Uniformità LED Res. acqua salata Res. ai solventi Prot. dai raggi UV Prod. dimmerabile |
| Fastening Fissaggio | Aluminium Mounting clips Aluminium Profile Adjustable clips | Clip di montaggio in alluminio Profilo in alluminio Clip orientabili |
| Screen Schermo | Silicone rubber | Gomma siliconica |
| Reel length Lunghezza bobina | → 5 m • 16,4 ft reel with power cables at both ends / Bobina 5 m con cavi di alimentazione in entrambe le estremità | |
| Cutting pitch Passo di taglio | 166,6 mm • 6,56 " | 166,6 mm |
| Finishing Finitura | <input type="radio"/> White | <input type="radio"/> Bianca |
| Max. ambient temperature Temperatura ambiente max. | 45 °C | 45 °C |

Listings and marks

Certificazioni e marchi



Light Luce

| | |
|---|------------------------------------|
| Power consumption Consumo energia | 18,0 W/m • 5,5 W/ft |
| CCT K | ● 2700 K ● 3000 K ● 4000 K |
| CRI | ≥ 90 |
| Delivered lumen output Flusso luminoso emesso ● 3000 K | 94,9 lm/W 1708 lm/m • 521 lm/ft |
| Max. run length Lunghezza massima | 5 m • 16,4 ft |
| Input voltage Tensione di ingresso | 24 V DC |

TOOL Grazer 12

Dimensions Dimensioni

Scale/Scala 1:2

Integral Cap (IP67)
Tappo integrato (IP67)

IA → Straight
IA → Dritta

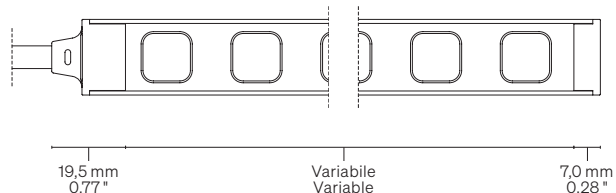
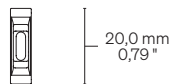

Cable outlet Uscita Cavi

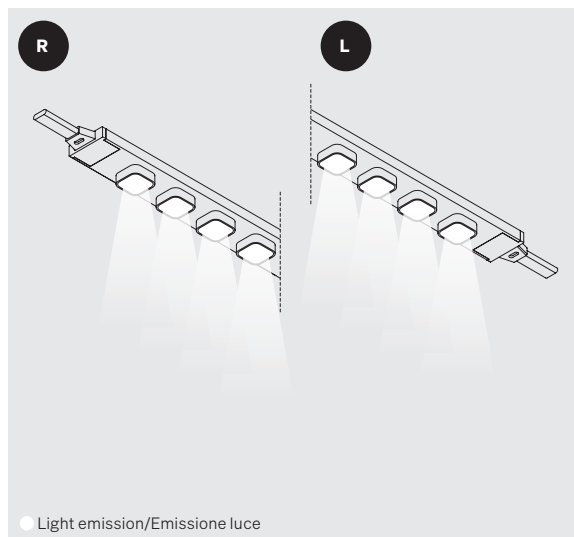

TOOL Grazer 12

Cutting point information Informazioni segno di taglio

Scale/Scala 1:2

- 1 Up to 5 m • 16,40 ft with one power supply
Fino a 5 m con unica alimentazione

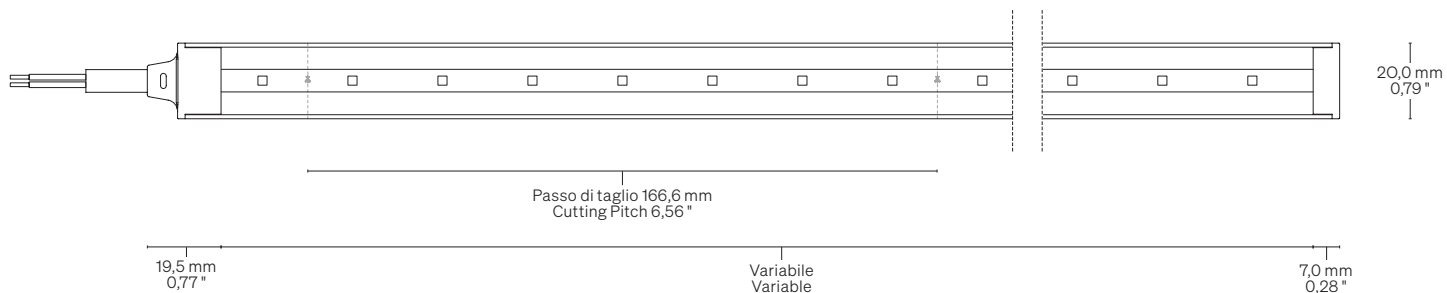

Curvature radius Raggio di curvatura

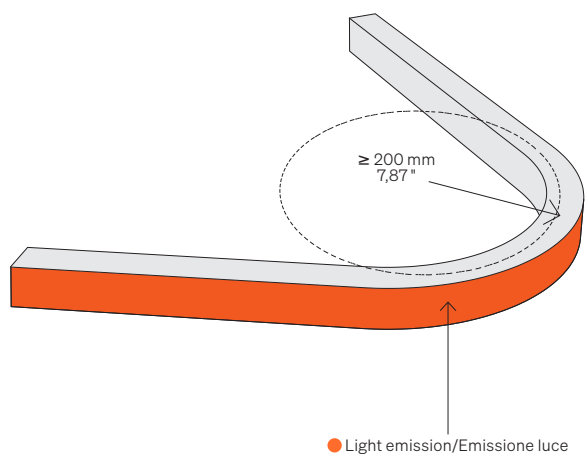

Direction of bending Senso di curvatura

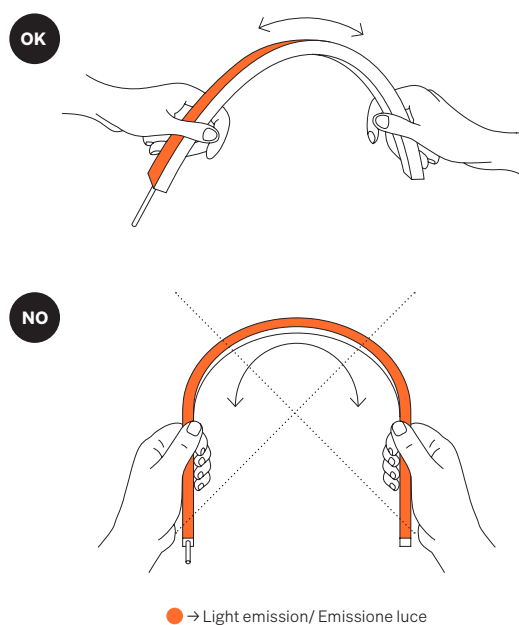

TOOL Grazer 12

Fastening options Opzioni di fissaggio

Scale/Scala 1:1

TOCGR12

Aluminium Mounting clips → Use for furniture with curved lines
 Clip di montaggio in alluminio → Utilizzare per arredi con linee curve

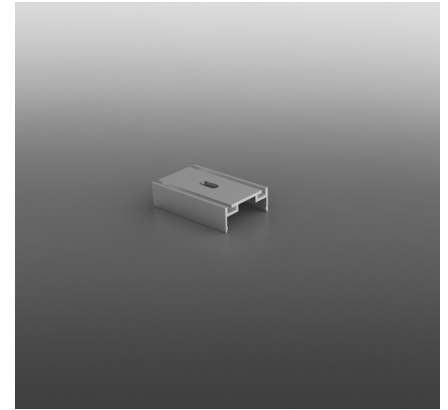
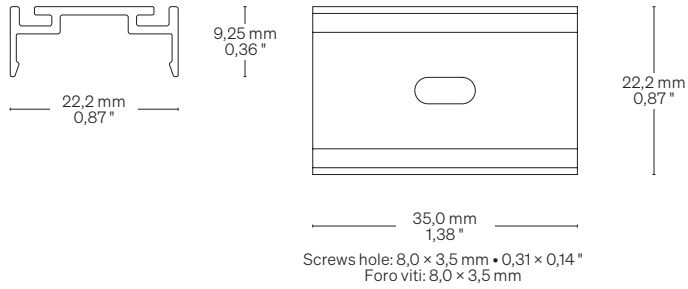

TOUGR121

Aluminium profile → Use for furniture with straight lines
 Profilo in alluminio → Utilizzare per arredi con linee dritte

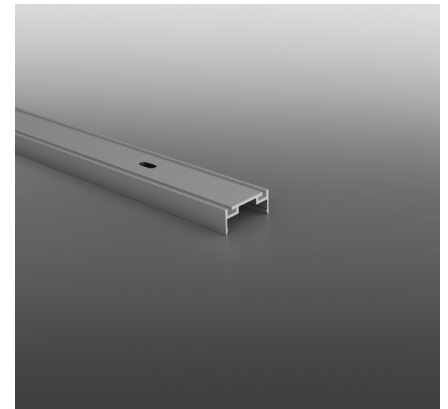
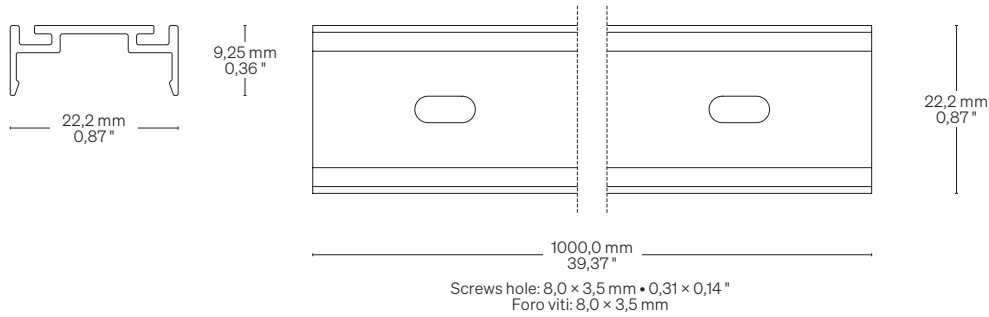

TOACGR12

Adjustable clips → Use for furniture with curved lines
 Clip orientabili → Utilizzare per arredi con linee curve

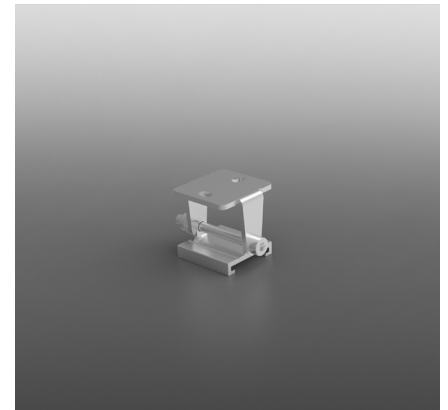
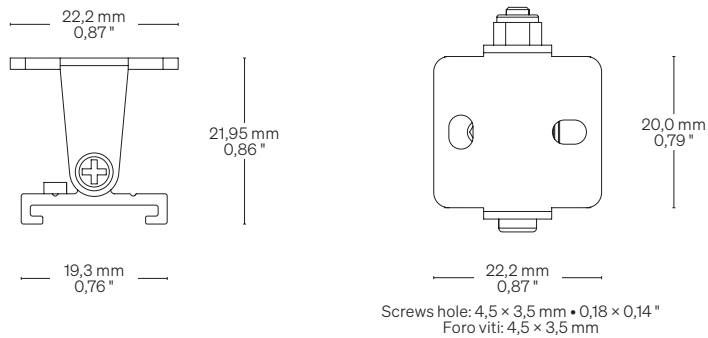

TOOL Grazer 12

Code for customised order Codice per ordine su misura



| | | |
|--|---|---|
| Basic codes Codici base | • TOGR1218 | TOOL Grazer 12 18,0 W/m • 5,5 W/ft |
| CCT K CCT K | • 27 • 30 • 40 | ● 2700 K ● 3000 K ● 4000 K |
| Cable outlet (Integral cap) Uscita cavo (T. integrato) | • IA | Straight/Dritta |
| Order length Lunghezza ordinabile | • -- | Specify the size Specificare la misura |

| | |
|--|--|
| Order example Esempio ordine | • TOGR1218 27 IA • 0,32 |
| | TOOL Grazer 12, 18,0 W/m • 5,5 W/ft, Warm White 2700, Integral cap straight cable outlet • 0,32 m |
| | TOOL Grazer 12, 18,0 W/m, Warm White 2700, Uscita cavo dritta con tappo integrato • 0,32 m |

Fastening Fissaggio

| | | |
|--|------------------|--|
| Fastening options Opzioni di fissaggio | • TOCGR12 | Aluminium Mounting clips Clip di montaggio in alluminio |
| | TOUGR121 | Aluminium Profile Profilo in alluminio |
| | TOACGR12 | Adjustable clips Clip orientabili |

TOOL Grazer 12

Code for coil Codice ordine per bobina



Basic codes Codici base

• **R5TOGR1218** TOOL Grazer 12
Coil/Bobina 5 m • 16,4 ft
18,0 W/m • 5,5 W/ft

CCT K CCT K

• **27** ● 2700 K
30 ● 3000 K
40 ● 4000 K

Order example Esempio ordine

• **R5TOGR1218 27**

TOOL Grazer 12 Coil 5 m • 16,4 ft,
18,0 W/m • 5,5 W/ft, Warm White 2700,
Straight cable outlet

TOOL Grazer 12 Bobina 5 m, 18,0 W/m,
Warm White 2700, Uscita cavo dritta

Fastening and cable outlet caps Fissaggio e tappi uscita cavo

Fastening options Opzioni di fissaggio

• **K10TOCGR12** Aluminium Mounting clips
Clip di montaggio in alluminio
TOUGR121 Aluminium Profile
Profilo in alluminio
K10TOACGR12 Adjustable clips
Clip orientabili

End caps Tappi di chiusura

• **K10TOGR12EC** End caps
Tappi di chiusura

Warnings Avvertenze

The installation of the product, must be done as illustrated in the catalogue or inside the technical data-sheet that can be asked to the manufacturer. An installation performed differently from the one indicated may compromise the durability and characteristics of the product itself.

An installation performed differently from the one indicated may compromise the durability and characteristics of the product. Unsuitable cross-section / length of the cable can negatively affect the lighting power of the product. If Power supplies, even those with a plastic case, are located in spaces that are too small for their dimensions; they will be subjected to dissipation problems that will compromise their functionality. Silicones or resins subjected to temperature changes and used near the product, if not in accordance with the specifications issued by the manufacturer, they can seriously damage the LED component. The products can not be modified without any authorization by the manufacturer.

L'installazione del prodotto, dovrà eseguirsi come illustrato nel catalogo o nella documentazione tecnica richiedibile al produttore. Un'installazione eseguita diversamente da quella indicata, può compromettere la durata e le caratteristiche del prodotto.

Prima dell'installazione verificare la corretta sezione del cavo collegato tra LED e alimentatore. Sezione / lunghezza del cavo non congrui, possono alterare in negativo la luminosità del prodotto. Gli alimentatori, anche quelli con contenitore plastico, inseriti in spazi troppo piccoli, saranno soggetti a problemi di dissipazione che comprometteranno la loro funzionalità. Siliconi o resine soggetti a sbalzi di temperature e utilizzati in prossimità del prodotto, se non conformi alle specifiche rilasciate dal produttore possono danneggiare gravemente il componente LED. I prodotti non possono essere modificati senza autorizzazione da parte del produttore.